

- CONTACT CURRENT RATING: 1A.
- CONTACT RESISTANCE: 50 mΩ MAX.;
- INSULATION RESISTANCE: 1000Ω MIN.;
- DIELECTRIC WITHSTANDING: 500V AC MIN.;
- DURABILITY: 5,000 CYCLES MIN.;
- CONNECTOR MATING FORCES: 30N MAX.;
- CONNECTOR UNMATING FORCES: 3N MIN.;

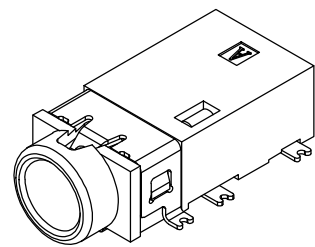

3D VIEW

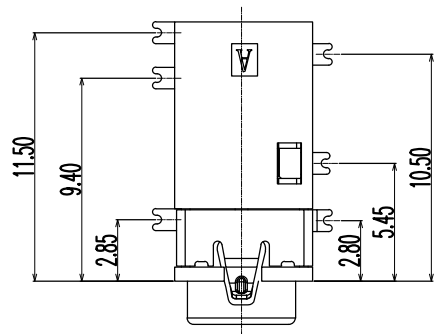
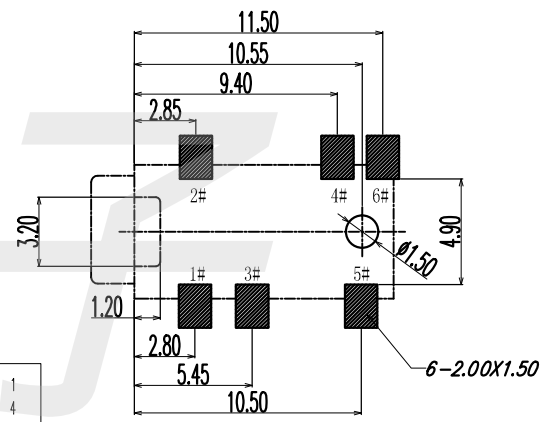
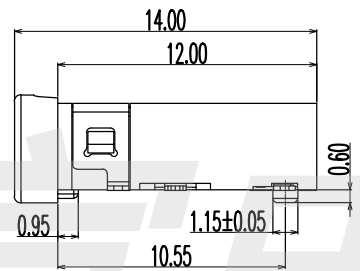
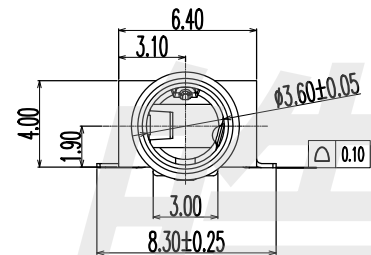

P.C.B LAYOUT
TOP VIEW

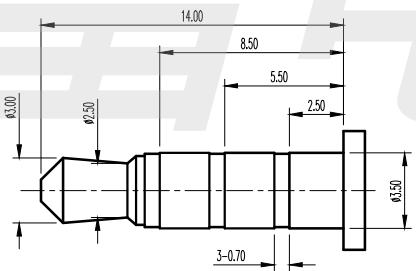
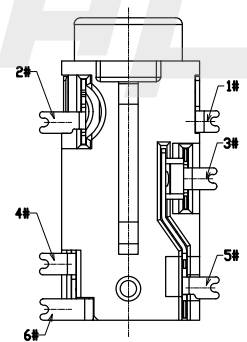

(ø3.50mm 4 POLE PLUG DETAIL DRAWING)

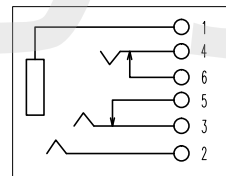

SCHEMATIC

ITEM	NAME	Q'TY	DESCRIPTION	NOTE
7	TERMINAL 6#	1		
6	TERMINAL 5#	1	PHOSPHOR BRONZE; NICKEL UNDER PLATING OVERALL,GOLD PLATING ON SOLDER AREA ;GOLD PLATING ON CONTACT AREA	
5	TERMINAL 4#	1		
4	TERMINAL 3#	1	PHOSPHOR BRONZE; NICKEL UNDER PLATING OVERALL,GOLD PLATING ON SOLDER AREA ;GOLD PLATING ON CONTACT AREA	
3	TERMINAL 2#	1		
2	TERMINAL 1#	1	PHOSPHOR BRONZE; THE BOTTOM OF THE NICKEL; THE WHOLE GOLD PLATING.	
1	HOUSING	1	PART COLOR BLACK	

HADFU ELECTRONCS TECHNOLOGY CO.,LTD

COPYRIGHT RESERVED,PLEASE DO NOT COPY.

PART NAME		PHONE JACK		DRAWING	Y,C,ZHANG	DWG.No.	SBICL
PART NO.		PJ-3160-ER		CHECK	G.C.Chen	REV.	A1
UNIT : mm	TOLERANCE OTHERWISE	UP TO 5 ±0.2	±0.3	APPROVAL	SCALE	DATE	
		ABOVE 5~30 ±0.5	±0.5			PAGE	1 OF 1
		ANGLE	0°±3'				