

RoHS  
Compliant

SYMBOL	REVISION	APPROVAL	DATE

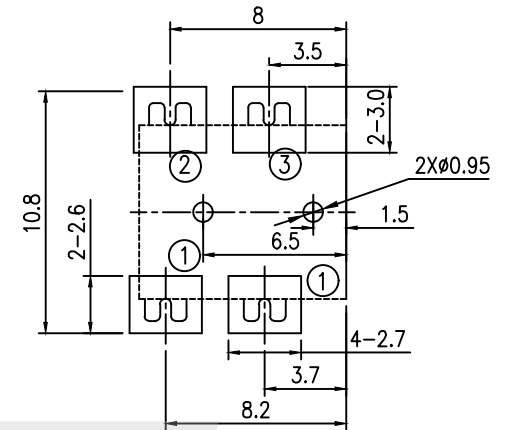

P.C.B LAYOUT  
TOP VIEW

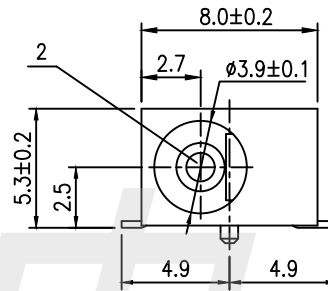
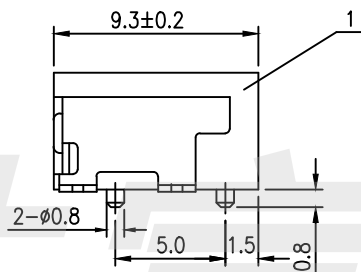
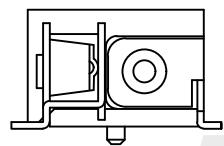
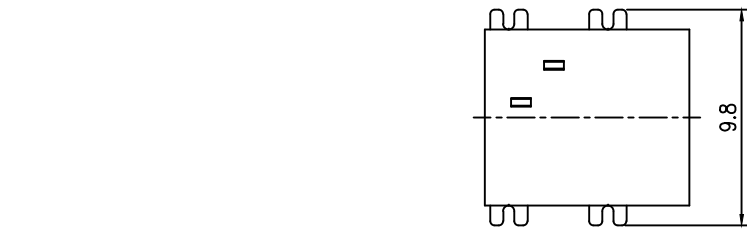
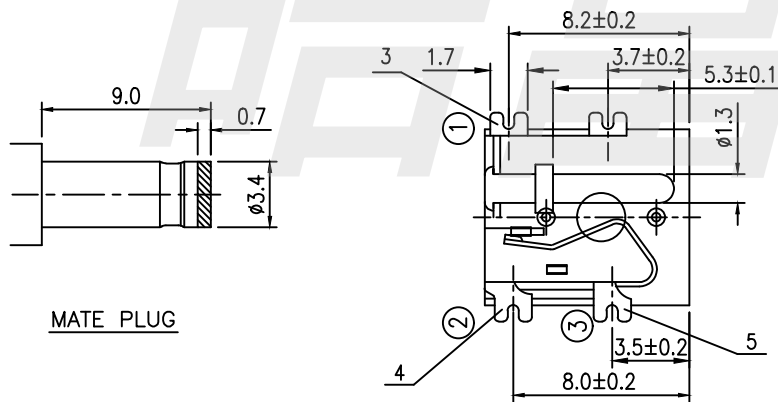

MATE PLUG

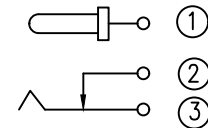

CIRCUIT

5	TERMINAL	C5210	1	Ag PLATED
4	TERMINAL	C2680	1	Ag PLATED
3	TERMINAL	C2680	1	Ag PLATED
2	PIN	C3604	1	Ni PLATED
1	HOUSING	PPA	1	BLACK
NO.	PARTS	MATERIAL	QTY.	FINISHING

HAOFU ELECTRONCS TECHNOLOGY CO.,LTD

COPYRIGHT RESERVED,PLEASE DO NOT COPY.

PART NAME		DC POWER JACK		DRAWING	M.M.Zhang	DWG.No.	SBD17
PART NO.		DC-033		CHECK	G.C.Chen	REV.	A
UNIT :	TOLERANCE OTHERWISE	UP TO 5	±0.2	ANGLE	APPROVAL	DATE	
		ABOVE 5 ~30	±0.3				
mm		ABOVE 30	±0.5	0°±3'	SCALE	PAGE	1 OF 1
		ANGLE	±3'				