

RoHS
Compliant

- CONTACT CURRENT RATING: 1A.
- CONTACT RESISTANCE: 50 mΩ MAX.;
- INSULATION RESISTANCE: 1000Ω MIN.;
- DIELECTRIC WITHSTANDING: 500V AC MIN.;
- DURABILITY: 5,000 CYCLES MIN.;
- CONNECTOR MATING FORCES: 29.4N (3.00Kgf) MAX.;
- CONNECTOR UNMATING FORCES: 2.94N(0.30Kgf) MIN.;

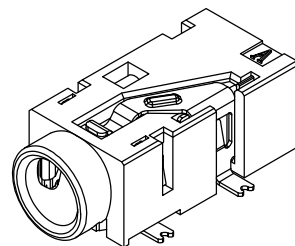

3D VIEW

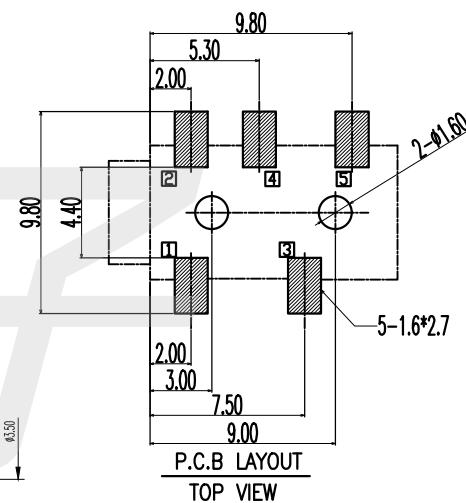
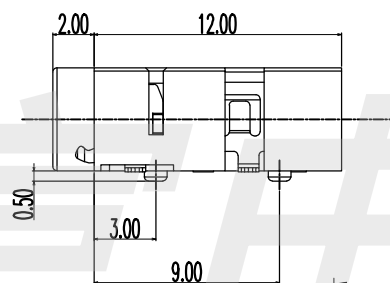
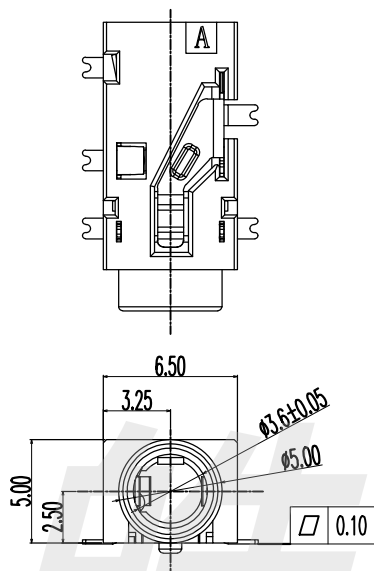

P.C.B LAYOUT
TOP VIEW

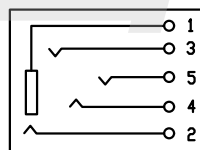
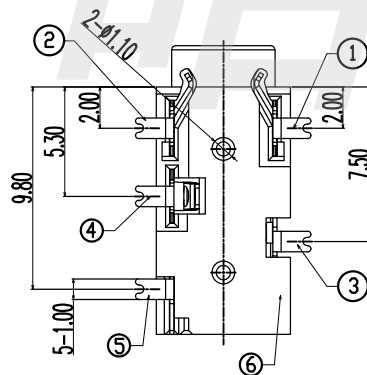

SCHEMATIC

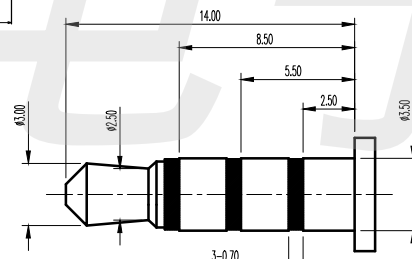

(Ø3.50mm 4 POLE PLUG DETAIL DRAWING)

6	HOUSING	1	PPA COLOR BLACK	
5	CONTACT 5#	1	PHOSPHOR BRONZE; NICKEL(40u"MIN.) UNDER PLATING OVERALL;TIN WHOLE THE (80u"MIN.) OVERALL	
4	CONTACT 4#	1	PHOSPHOR BRONZE; NICKEL(40u"MIN.) UNDER PLATING OVERALL;TIN WHOLE THE (80u"MIN.) OVERALL	
3	CONTACT 3#	1	PHOSPHOR BRONZE; NICKEL(40u"MIN.) UNDER PLATING OVERALL;TIN WHOLE THE (80u"MIN.) OVERALL	
2	CONTACT 2#	1	PHOSPHOR BRONZE; NICKEL(40u"MIN.) UNDER PLATING OVERALL;TIN WHOLE THE (80u"MIN.) OVERALL	
1	CONTACT 1#	1	PHOSPHOR BRONZE; NICKEL(40u"MIN.) UNDER PLATING OVERALL;TIN WHOLE THE (80u"MIN.) OVERALL	
ITEM	NAME	Q'TY	DESCRIPTION	NOTE

HAOFU ELECTRONCS TECHNOLOGY CO.,LTD

COPYRIGHT RESERVED,PLEASE DO NOT COPY.

PART NAME		PHONE JACK		DRAWING		Y,C,ZHANG		DWG.No.		SBICL		
PART NO.		PJ-327F-BR		CHECK		G.C.Chen		REV.		A1		
UNIT :	TOLERANCE OTHERWISE	UP TO 5		ANGLE	APPROVAL		DATE		PAGE		1 OF 1	
		ABOVE 5 ~30			SCALE							
mm		±0.2	±0.3	0°±3'			2:1					