

1. CONTACT CURRENT RATING: 1A.
2. CONTACT RESISTANCE: 100 mΩ MAX.;
3. INSULATION RESISTANCE: 100Ω MIN.;
4. DIELECTRIC WITHSTANDING: 500V AC MIN.;
5. DURABILITY: 5,000 CYCLES MIN.;
6. CONNECTOR MATING FORCES: 30N MAX.;
7. CONNECTOR UNMATING FORCES: 3N MIN.;
8. TERPROOF LEVEL: IP67;

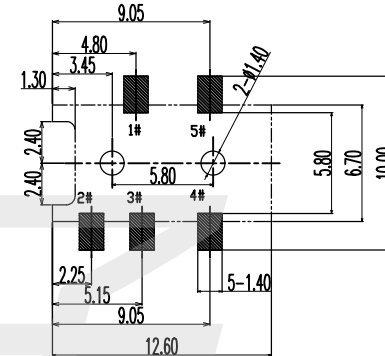

P.C.B LAYOUT  
BOTTOM VIEW

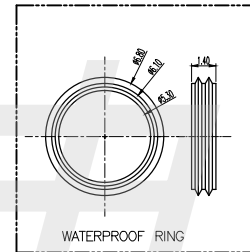
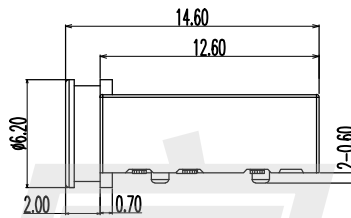
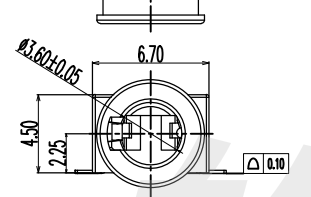
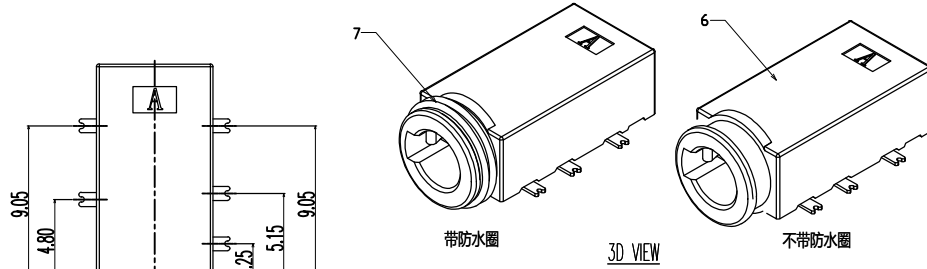
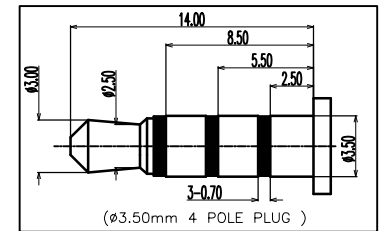
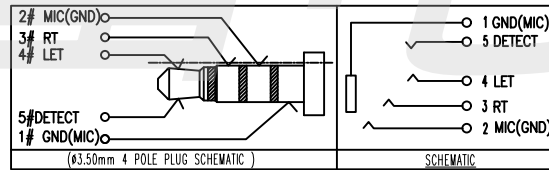
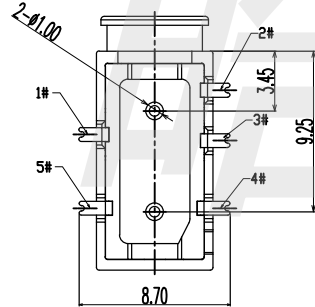

7	WATERPROOF RING	1	SILICA GEL	
6	HOUSING	1	HIGH TEMPERATURE PLASTIC MATERIALE; COLOR BLACK	
5	TERMINAL 5#	1	STAINLESS STEEL; NICKEL UNDER PLATING OVERALL,GOLD FLASH PLATING ON SOLDER AREA ;GOLD FLASH PLATING ON CONTACT AREA	T=0.20mm
4	TERMINAL 4#	1	STAINLESS STEEL; NICKEL UNDER PLATING OVERALL,GOLD FLASH PLATING ON SOLDER AREA ;GOLD FLASH PLATING ON CONTACT AREA	T=0.20mm
3	TERMINAL 3#	1	PHOSPHOR BRONZE; NICKEL UNDER PLATING OVERALL,GOLD FLASH PLATING ON SOLDER AREA ;GOLD FLASH PLATING ON CONTACT AREA	T=0.20mm
2	TERMINAL 2#	1	PHOSPHOR BRONZE; NICKEL UNDER PLATING OVERALL,GOLD FLASH PLATING ON SOLDER AREA ;GOLD FLASH PLATING ON CONTACT AREA	T=0.20mm
1	TERMINAL 1#	1	STAINLESS STEEL; NICKEL UNDER PLATING OVERALL,GOLD FLASH PLATING ON SOLDER AREA ;GOLD FLASH PLATING ON CONTACT AREA	T=0.20mm
ITEM	NAME	Q'TY	DESCRIPTION	NOTE

HAOFU ELECTRONCS TECHNOLOGY CO.,LTD

COPYRIGHT RESERVED,PLEASE DO NOT COPY.

PART NAME		PHONE JACK		DRAWING	Y,C,ZHANG	DWG.No.	SBICL
PART NO.		PJ-380-B		CHECK	G.C.Chen	REV.	A1
UNIT : mm	TOLERANCE	UP TO 5	±0.2	APPROVAL	SCALE	DATE	
	OTHERWISE	ABOVE 5 ~30	±0.3			PAGE	1 OF 1
		ABOVE 30	±0.5		2:1		
		ANGLE	±3°				