

说明:

1. 胶芯: LCP 黑色; UL94V-0.
2. 端子: C2680 T=0.15mm, 半金镍1u" (功能)
3. 外壳: SUS304 T=0.25mm, 镀镍
4. 额定电流: 1 A 最大.
5. 耐电压: 100V(AC) /1分钟 至少.
6. 接触阻抗: 50m Ω 最大.
7. 绝缘阻抗: 100M Ω 最小.
8. 插入力: 3.57 Kgf 最大.
9. 拔出力: 1.0 Kgf 初始 最小; 测试后 0.81 Kgf 最小
10. 温度范围: -30°C~+80°C

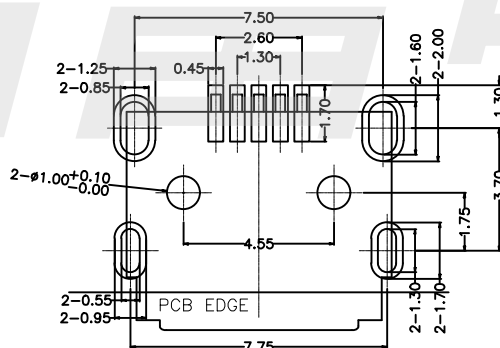
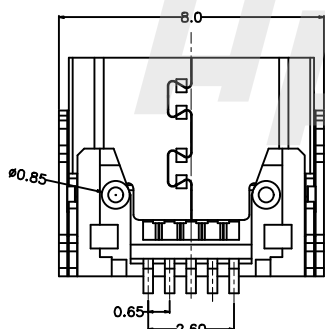
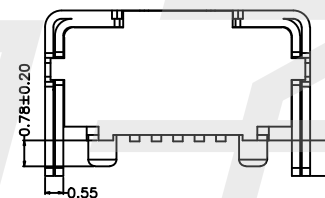
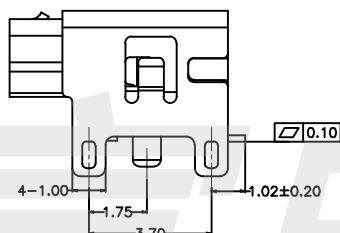
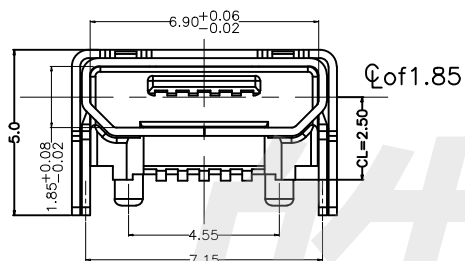
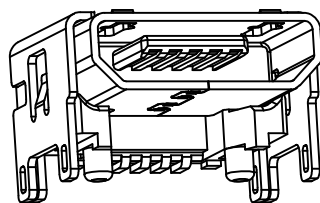
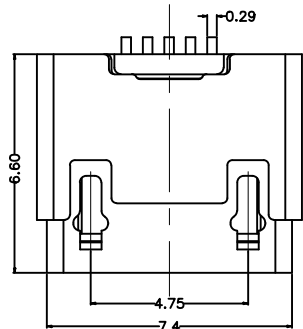

RECOMMENDED PCB LAYOUT

TOL:±0.10(TOP VIEW)

④	CONTACT	----	5	Copper Alloy T=0.20	Au/Sn Plated, Ni Under plated
③	SHELL	----	1	Stainless Steel T=0.25	Ni/Cu PLATED
②	COVER	----	1	Stainless Steel T=0.25	Ni/Cu PLATED
①	HOUSING	----	1	LCP	Black, UL94V-0
NO	PART	P/N	NUM	MATERIAL	MARK

HAOFU ELECTRONICS TECHNOLOGY CO.,LTD

COPYRIGHT RESERVED, PLEASE DO NOT COPY.

PART NAME		CONNECTOR		DRAWING	Y,C,ZHANG	DWG.No.	SBICL
PART NO.		MICRO 5P BH2.5 WSL1.0 NC		CHECK	G.C.Chen	REV.	A1
UNIT :	TOLERANCE OTHERWISE	UP TO 5	±0.2	ANGLE	APPROVAL	DATE	PAGE
		ABOVE 5~30	±0.3				
mm		ABOVE 30	±0.5	0°±3'	SCALE	2:1	1 OF 1