

RoHS
Compliant

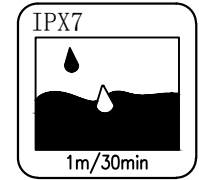

NOTE:

- MECHANICAL PERFORMANCE,
 - 1-1.INSERTION FORCE: 0.5~2.0kgf.
 - 1-2.REMOVAL FORCE: 0.8kgf~2.0kgf.
 - 1-3.DURABILITY: 10000 CYCLES.
- ELECTRICAL PERFORMANCE,
 - 2-1. CURRENT RATING:3.0A
VOLTAGE RATING:5.0V
 - 2-2. LLCR:
VBUS & GND PINS AND OTHER PINS: 40mΩ/PIN MAX.
SHIELD: 50mΩ/MAX.
LLCR MAX. CHANGE OF ALL PINS: 10mΩ.
 - 2-3.INSULATION RESISTANCE: 100MΩ MIN
 - 2-4.DIELECTRIC WITHSTAND VOLTAGE,AC 100V FOR 1 MINUTE.
- ENVIRONMENTAL PERFORMANCE:
OPERATING TEMPERATURE: -25°C~+85°C.
- IR REFLOW:
THE PEAK TEMPERATURE ON THE BOARD SHALL BE MAINTAINED FOR 10 SECONDS AT 260°C.

A1	GND	B12	GND
A2	SSTXP1	B11	SSTXP1
A3	SSTXN1	B10	SSTXN1
A4	VBUS	B09	VBUS
A5	CC1	B08	VBUS
A6	DP1	B07	DN2
A7	DN1	B06	DP2
A8	SBU1	B05	CC2
A9	VBUS	B04	VBUS
A10	SSRXN2	B03	SSRXN2
A11	SSRXP2	B02	SSRXP2
A12	GND	B01	GND
PIN	SIGNAL NAME	PIN	SIGNAL NAME

NO	DESCRIPTION	QTY	MATERIAL	REMARKS
1	Rear high	1PCS	PA10T	BLACK
2	SHELL HOUSING	1PCS	PA10T	BLACK
3	CONTACT	1SET	C7025	接触, SMT 1u"
4	Bracket	1PCS	STAINLESS STEEL	镀镍 30u"
5	SHELL	1PCS	STAINLESS STEEL	镀镍 30u"
6	Middle clip	1PCS	STAINLESS STEEL	Cleaning
7	Run-RING	1PCS	Silica gel	BLACK

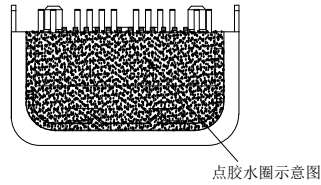

点胶水圈示意图

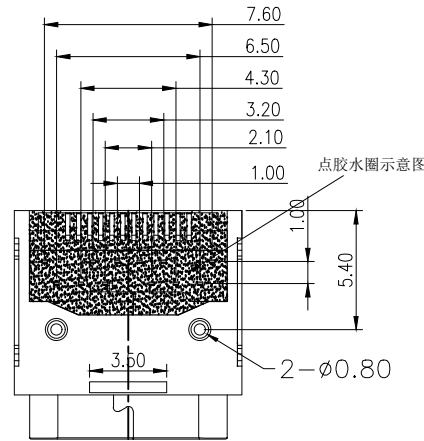

点胶水圈示意图

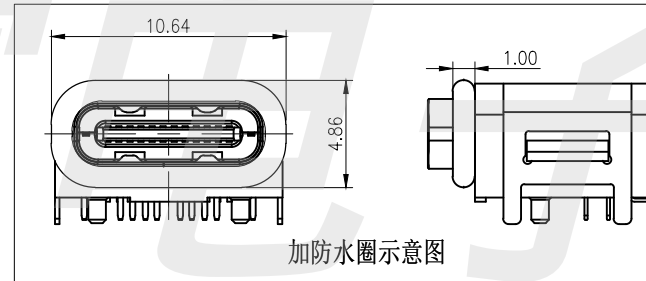

加防水圈示意图

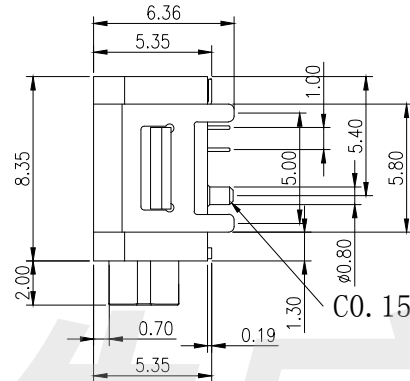
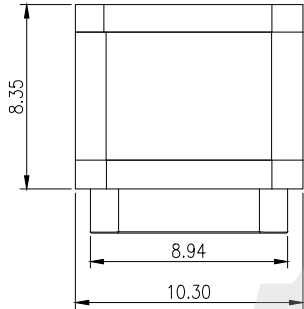

φ0.15

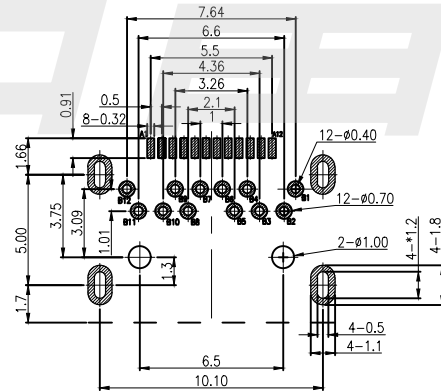
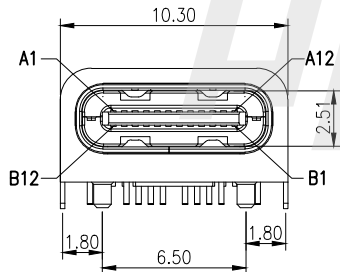

RECOMMENDED PCB LAYOUT
Tolerance:±0.05mm

HAOFU ELECTRONCS TECHNOLOGY CO., LTD

COPYRIGHT RESERVED,PLEASE DO NOT COPY.

PART NAME		TYPE-C 24pin wp		DRAWING		Y,C,ZHANG		DWG.No.		SBICL	
PART NO.		HOF-24PTBWP-TPC		CHECK		G.C.Chen		REV.		A1	
UNIT :		TOLERANCE		ANGLE		APPROVAL		DATE			
mm		OTHERWISE		°±3'		SCALE		PAGE		1 OF 1	
		UP TO 5 ABOVE 5~30 ABOVE 30 ANGLE						2:1			