

RoHS
Compliant

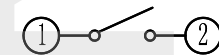
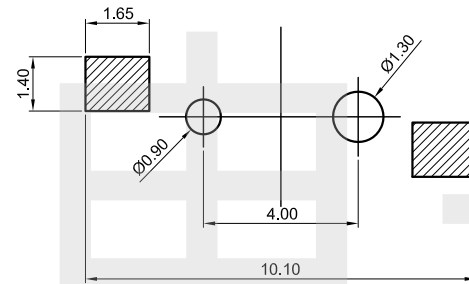
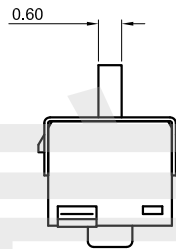
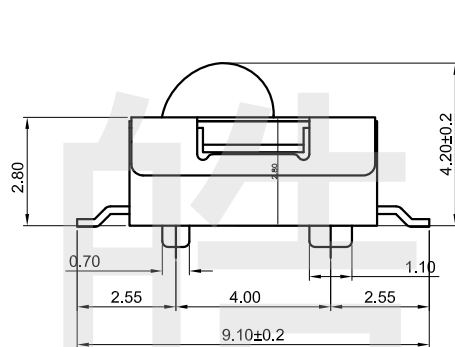
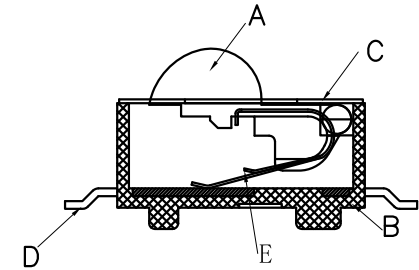
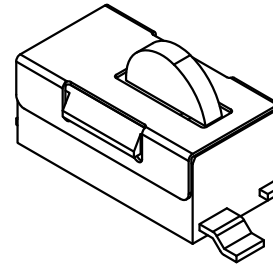
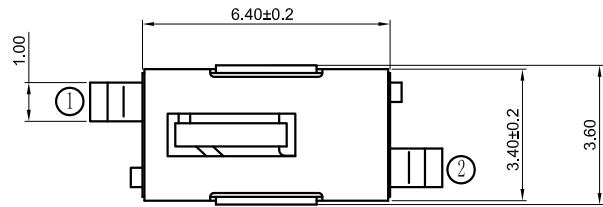

电气原理图

PCB. 焊接尺寸图

项目	标准
电气性能	额定电流: 0.1A
	额定电压: 12V DC
	接触电阻: 200mΩ max.
	绝缘电阻: 100MΩ min.100V DC
	耐压强度: 100V AC (50/60Hz foy 1 minute)
机械性能	操作力度: 60±40gf
	工作寿命: 50000cycles
	总行程: 1.4mm±0.2mm
	接触行程: 0.6±0.25mm
环境性能	温度范围: -10°C ~ +60°C.

E	簧片	1	铍青铜 T=0.07	镀银	银白色	
D	嵌件	1	黄铜 T=0.2	镀银	银白色镶银	
C	盖子	1	SUS 304 T=0.1	/	原色	
B	底座	1	LCP	/	黑色	
A	按钮	1	LCP	/	黑色	
NO.	零件名称 Part Name	Q'TY	材料 Material	镀涂 Plating coating	颜色 colour	备注 Remarks

HAOFU ELECTRONCS TECHNOLOGY CO.,LTD

COPYRIGHT RESERVED,PLEASE DO NOT COPY.

PART NAME		DETECTION SWITCH		DRAWING		Y,C,ZHANG		DWG.No.		SBICL	
PART NO.		TD-1216SA-02		CHECK		G.C.Chen		REV.		A1	
	UNIT :	TOLERANCE	UP TO 5	±0.2	ANGLE	APPROVAL		DATE			
	mm		OTHERWISE	ABOVE 5~30							
			ABOVE 30	±0.5		SCALE	2:1	PAGE		1 OF 1	