

性能:

额定电流: 1.0A
 额定电压: 12V
 耐电压: 500V
 接触电阻: 30mΩ MAX
 绝缘电阻: 500MΩ
 工作温度: -40℃~+85℃
 塑件(材质): LCP E130I
 接触点(材质): 铜合金, 触点镀金15μ

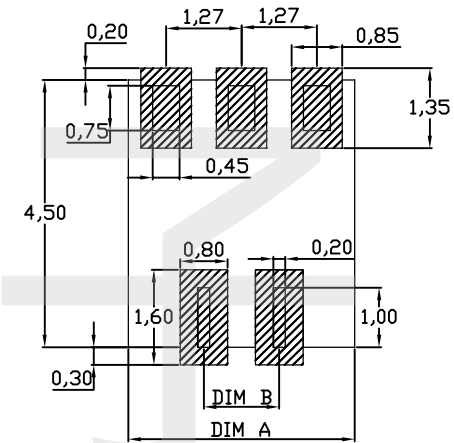

RECOMMENDED PCB LAYOUT
 TOP VIEW (. XX±0.05)

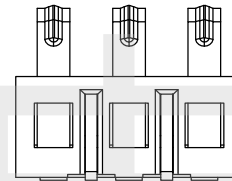
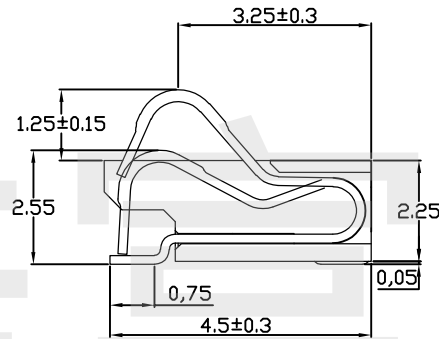
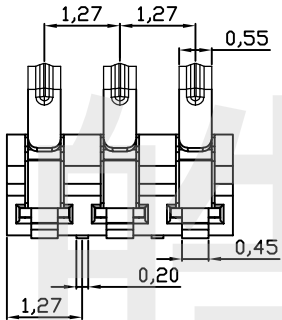
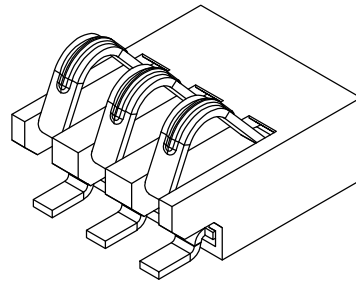
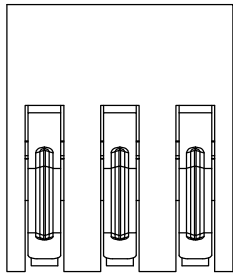
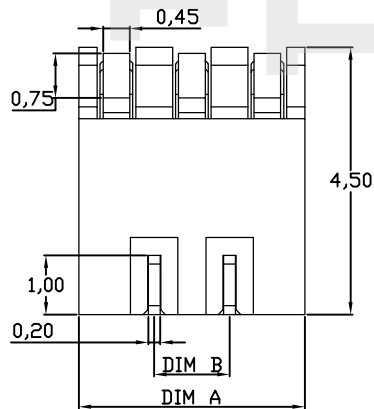

PART NO.	DIM A	DIM B
BC2P127H225	2.54	/
BC3P127H225	3.81	1.27
BC4P127H225	5.08	2.54
BC5P127H225	6.35	3.81
BC6P127H225	7.62	5.08

HAOFU ELECTRONICS TECHNOLOGY CO.,LTD

COPYRIGHT RESERVED,PLEASE DO NOT COPY.

PART NAME		CONNECTOR		DRAWING	Y,C,ZHANG	DWG.No.	SBICL
PART NO.		BCNP127H225		CHECK	G.C.Chen	REV.	A1
UNIT : mm	TOLERANCE OTHERWISE	UP TO 5	±0.2	ANGLE	APPROVAL	DATE	PAGE
		ABOVE 5~30	±0.3				
		ABOVE 30	±0.5		SCALE	2:1	1 OF 1
		ANGLE	±3'				