

RoHS Compliant
Halogen Free

SYMBOL	REV.	REVISION	APPROVAL	DATE

CAD GENERATED DRAWING. DON'T CHANGE BY HAND.

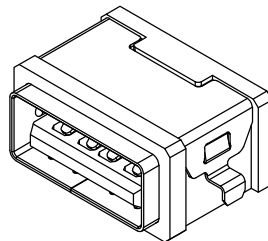
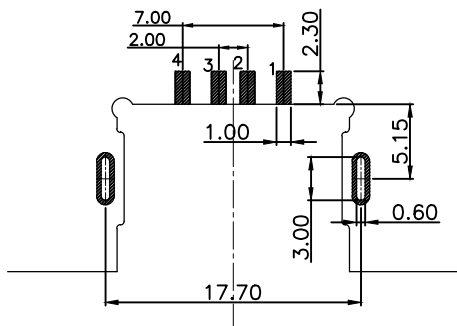
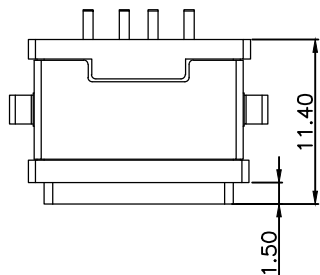

NOTES:

SPECIFICATION:

- CURRENT RATING: 3.0A MAX
- DIELECTRIC WITHSTAND VOLTAGE: 100VAC
- TEMPERATURE RANGE: -30 °C ~ 85 °C
- CONTACT RESISTANCE: 40 MILLIONHM MAX
- INSULATION RESISTANCE: 100 MEGOHMS MIN.
- INSERTION FORCE: 10N~30N
- UNMATING FORCE: 8N~30N
- DURABILITY: 1500 CYCLES
- Waterproof grade: IPX7

RECOMMENDED PCB LAYOUT(TOP VIEW)

THICKNESS T=1.0mm
DEFAULT TOLERANCE+/-0.05

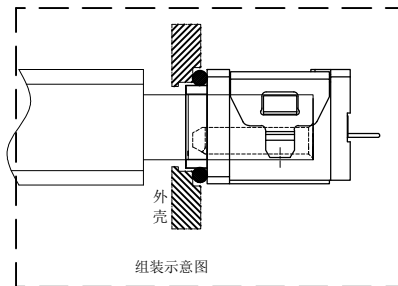
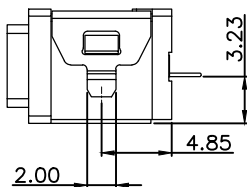
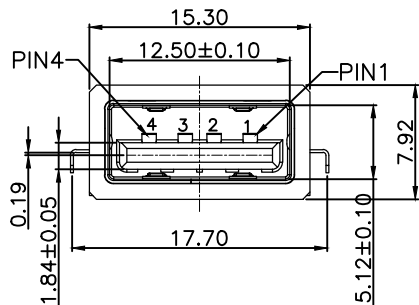

组装示意图

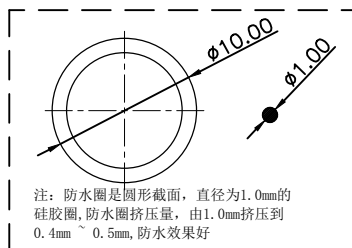
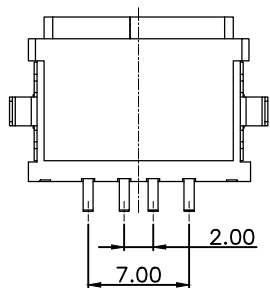

注: 防水圈是圆形截面, 直径为1.0mm的硅胶圈, 防水圈挤压力, 由1.0mm挤压力到0.4mm ~ 0.5mm, 防水效果好

PIN ASSIGNMENT

PIN NO.	1	2	3	4
SIGNAL NAME	VBUS	D-	D+	GND

ITEM	PART NAME	Q'TY	FINISH	NOTE
5	Outer Shell	1	SUS 301 1/4H	
4	Inner Shell	1	SUS 301 1/4H	
3	PLASTIC Shell	1	PA10T (G.F30%)	
2	Contact	4	BRASS C2680-EH Au/Ni Plating T=0.25mm	
1	Housing	1	PA10T (G.F30%)	

CIKI 东莞市皓富电子科技有限公司
DONGGUAN CITY HAOFU ELECTRONICS TECHNOLOGY CO., LTD

COPYRIGHT RESERVED, PLEASE DO NOT COPY.

PART NAME	WATERPROFF USB CONNECTOR	DRAWING	Z. L. Liang	DWG. No.
PART NO.	USB2.0 AF 90度SMT沉板3.23防水母座	CHECK	G. C. Chen	REV. A0
UNIT :	TOLERANCE UNLESS OTHERWISE SPECIFIED	ANGLE	G. C. Chen	DATE
mm	X.X ± 0.3 X.XX ± 0.2 X.XXX ± 0.1	±2°	SCALE	1:1
			PAGE	1 OF 1